



**WHITE
RHINO**

**CATÁLOGO
2026**



**MEJORA EL
DESEMPEÑO DE LOS
CILINDROS**



**MÁXIMA
RESISTENCIA
TELA KEVLAR**



**MAYOR
SEGURIDAD
OPERACIONAL**



**DISMINUYE
LA ROTACIÓN
DE COMPONENTE**

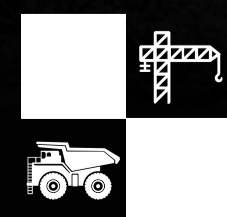

**INTERNATIONAL
CONSUMABLES**
MINING & CONSTRUCTION SOLUTIONS

**MANGA PROTECTORA
KEVLAR + PU**



**Correa de Fijación al
Puño del Vástago**



**Abrazadera de
Acero Ajustable**



Pegapega

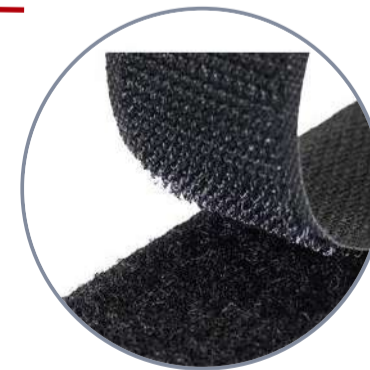

**TELA
KEVLAR**

100% Tenaz +
10 mm la capa +
90% Resistente al corte

**TELA
POLIURETANO**

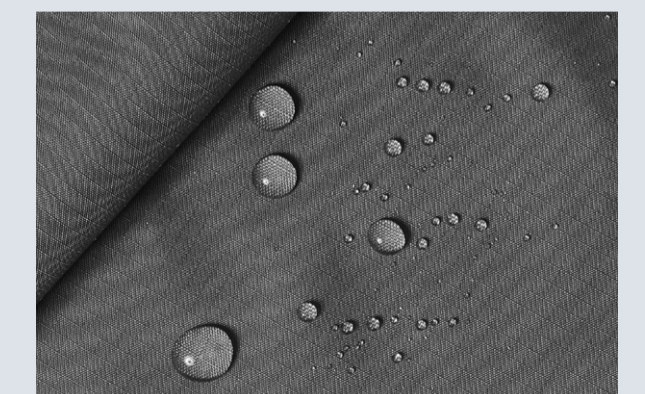

100% Impermeable

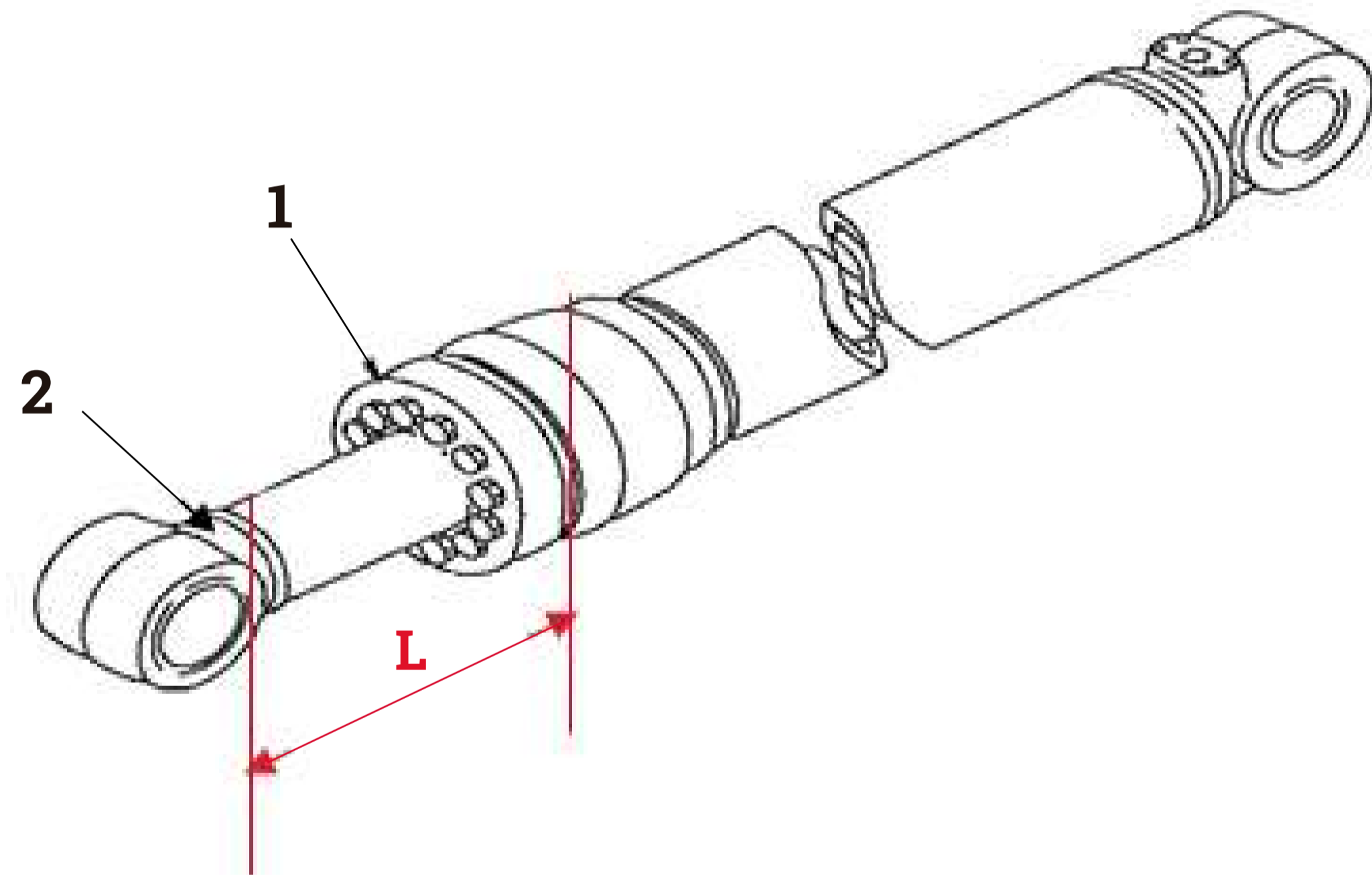
**MANGA PROTECTORA
KEVLAR + PU**

Item	NP	1 (mm)	2 (mm)	L (mm)
1	MPV-336KV-IC	260	140	1700
2	MPV-374KV-IC	360	180	1900
3	MPV-390KV-IC	400	200	2300
4	MPV-380KV-IC	210	110	1500
5	MPV-950KV-IC	400	180	2000

APLICAN EN:

PALA HIDRÁULICA



CARGADOR FRONTAL

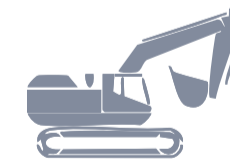

EXCAVADORAS



TRACTOR SOBRE ORUGAS



MOTONIVELADORA



SCOOP MINERO

📍 Nuestras sedes

Piura, Chiclayo, Cajamarca, Trujillo, Chimbote, Huaraz, Lima, Arequipa y Cusco

 🌐 www.internationalconsumables.com



**WHITE
RHINO**



WWW.INTERNATIONALCONSUMABLES.COM



In Memoriam: Ing. Javier Francisco Obregon Mantilla
15 - 03 - 2021

 **959 211 438 / 924 487 121 / 991 479 906**

ventas@internationalconsumables.com
ventas02@internationalconsumables.com
ventas03@internationalconsumables.com

 **Nuestras sedes: Lima, Trujillo, Cajamarca y Piura**